



Assembly Precautions for the Nichia 064 Series LEDs

Table of contents

1.	<u>LED Outline Dimensions/Tape and Reel Dimensions</u>	2
2.	<u>Handling Precautions</u>	3
3.	<u>Design Recommendations for Optimal Amount of Solder</u>	4
4.	<u>Precautions for Setting Up a Pick-and-Place Machine/Nozzle</u>	5-9
5.	<u>Precautions When Reflow Soldering</u>	9

NSSW064A and NxSx064x refer to Nichia part numbers. These Nichia part numbers within this document are merely Nichia's part numbers for those Nichia products and are not related nor bear resemblance to any other company's product that might bear a trademark.

This document contains tentative information, Nichia may change the contents without notice.

1. LED Outline Dimensions/Tape and Reel Dimensions

Table 1. NxSx064x Product Specifications

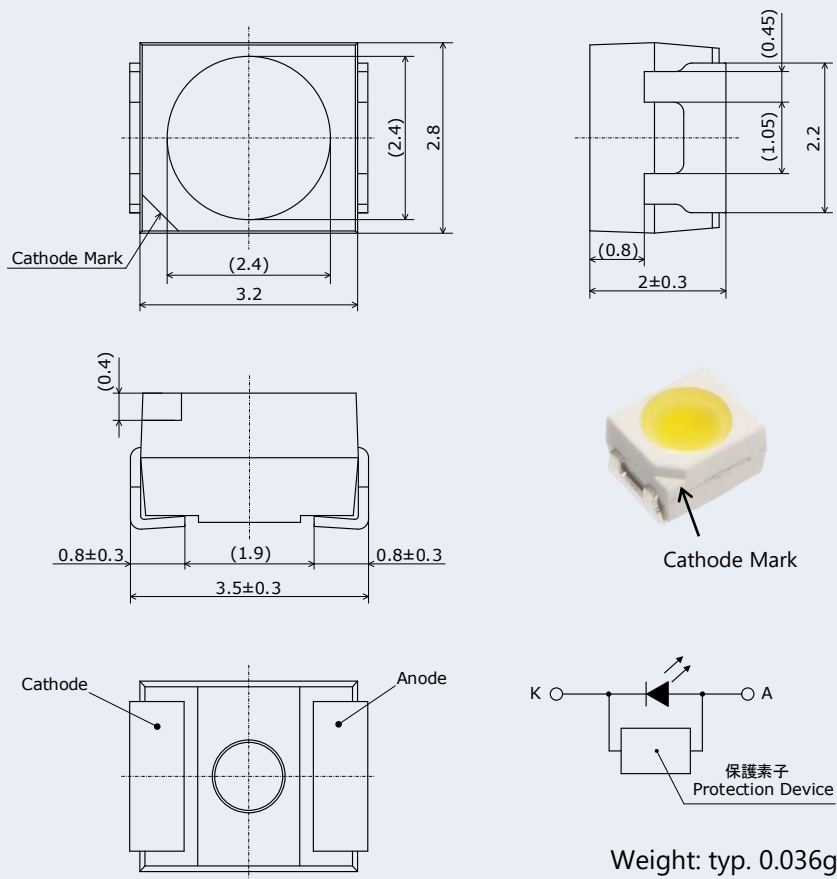
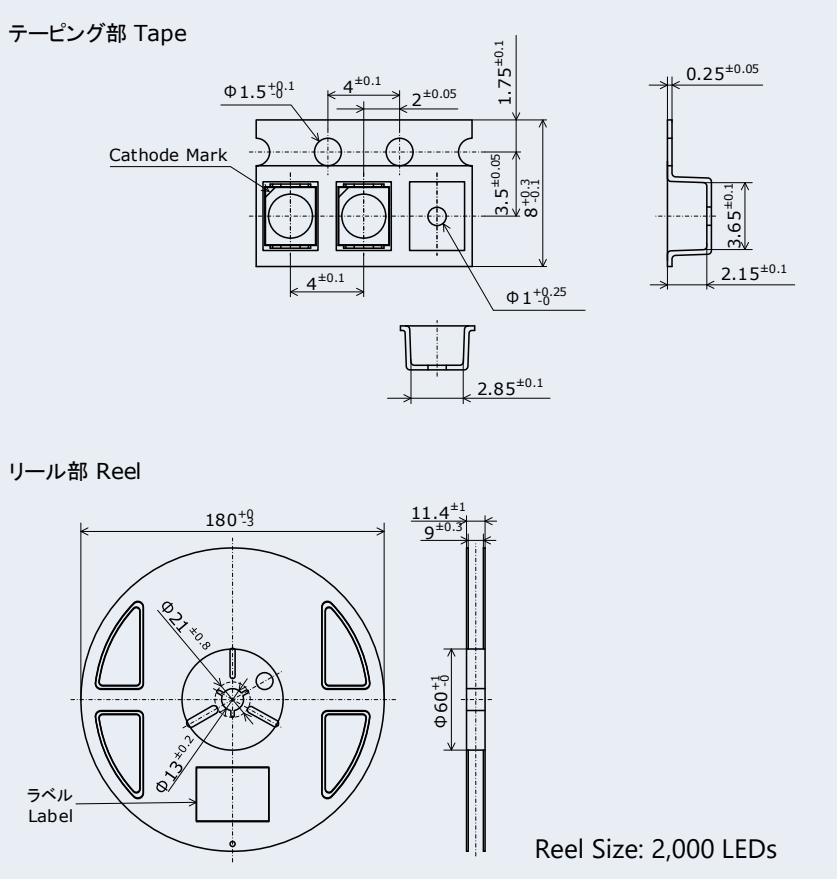
LED	Embossed Carrier Tape
 <p> LED dimensions: Top view shows a square package with a diameter of 2.4 mm and a total width of 3.2 mm. The height is 2.8 mm. A side view shows a thickness of 2.2 mm with a top chamfer of 0.45 mm and a bottom chamfer of 1.05 mm. The bottom view shows a width of 3.5 mm with 0.8 mm offsets on each side and a central width of 1.9 mm. A photograph shows the LED with a yellow lens and a cathode mark. A circuit diagram shows the LED connected to a protection device (保護素子) between the cathode (K) and anode (A) terminals. </p> <p>Weight: typ. 0.036g (Unit: mm, Tolerance: ±0.2mm)</p>	 <p> テーピング部 Tape Dimensions: The tape has a width of 2.15 mm and a height of 3.65 mm. The carrier height is 2.85 mm. The LED pitch is 4 mm. The cathode mark diameter is 1.5 mm. The LED diameter is 1 mm. The distance from the cathode mark to the LED center is 2 mm. The distance between LED centers is 4 mm. The distance from the LED center to the edge of the carrier is 1.75 mm. The distance from the LED center to the edge of the tape is 3.5 mm. The distance from the LED center to the edge of the carrier is 8 mm. </p> <p> リール部 Reel Dimensions: The reel has an outer diameter of 180 mm and an inner diameter of 60 mm. The label diameter is 27 mm. The label width is 13 mm. The label height is 11.4 mm. The label offset is 9 mm. </p> <p>Reel Size: 2,000 LEDs (Unit: mm)</p>

The weight value provided in Table 1 is the weight for the NSSW064A LED.

This document contains tentative information, Nichia may change the contents without notice.

2. Handling Precautions

2-1. Handling with Bare Hands

Do not handle the LEDs with bare hands:

- this may contaminate the LED surface and have an effect on the optical characteristics,
- this may cause the LED to deform and/or the wire to break causing a catastrophic failure (i.e. the LED not to illuminate),

2-2. Handling with Tweezers

Ensure that when handling the LEDs with tweezers, excessive force is not applied to the LED. Otherwise, it may cause damage to the resin (e.g. cut, scratch, chip, crack, delamination and deformation) and/or the wire to break causing a catastrophic failure.

2-3. ESD Precautions

The LEDs are sensitive to transient excessive voltages (e.g. ESD, lightning surge). If this excessive voltage occurs in the circuit, it may cause the LED to be damaged causing issues (e.g. the LED to become dimmer or not to illuminate [i.e. catastrophic failure]). When handling the LEDs, ensure that necessary measures have been taken to protect them from transient excess voltages. Refer to the applicable specification for more details.

2-4. Stacking Assembled PCBs Together

Do not stack assembled PCBs together. Otherwise, it may cause damage to the resin (e.g. cut, scratch, chip, crack, delamination and deformation) and the wire to break causing a catastrophic failure.

2-5. Baking

The NxSx064x LEDs are comparable to JEDEC Moisture Sensitivity Level (MSL) 3 or equivalent. Refer to IPC/JEDEC STD-020 for detailed information regarding the MSL. If the "after opening" storage time is exceeded, or if pink silica gel beads are found, make sure the LEDs are baked before use. Baking should be done only once. When baking the LEDs, remove the reel of the LEDs from the moisture-proof aluminum bag.

Table 2. Storage/Baking Conditions

	Conditions	Temperature	Humidity	Time
Storage	Before Opening the Moisture-proof Aluminum Bag	≤30°C	≤90%RH	Within 1 Year from Delivery Date
	After Opening the Moisture-proof Aluminum Bag	≤30°C	≤70%RH	Within 168 Hours
	Baking	65±5°C	-	≥24 Hours

✓ Correct

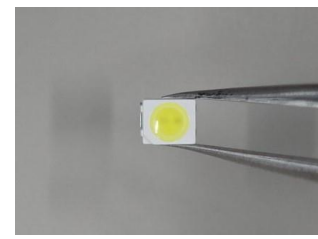

⊘ Incorrect

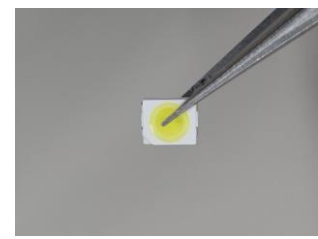

⊘ Incorrect

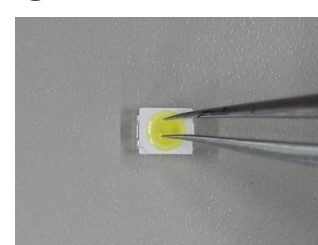

Figure 1. Correct/Incorrect Examples of Handling with Tweezers

This document contains tentative information, Nichia may change the contents without notice.

3. Design Recommendations for Optimal Amount of Solder

Soldering Pad Pattern/Metal Solder Stencil Aperture

Table 3. Recommended Soldering Pad Pattern/Metal Solder Stencil Aperture

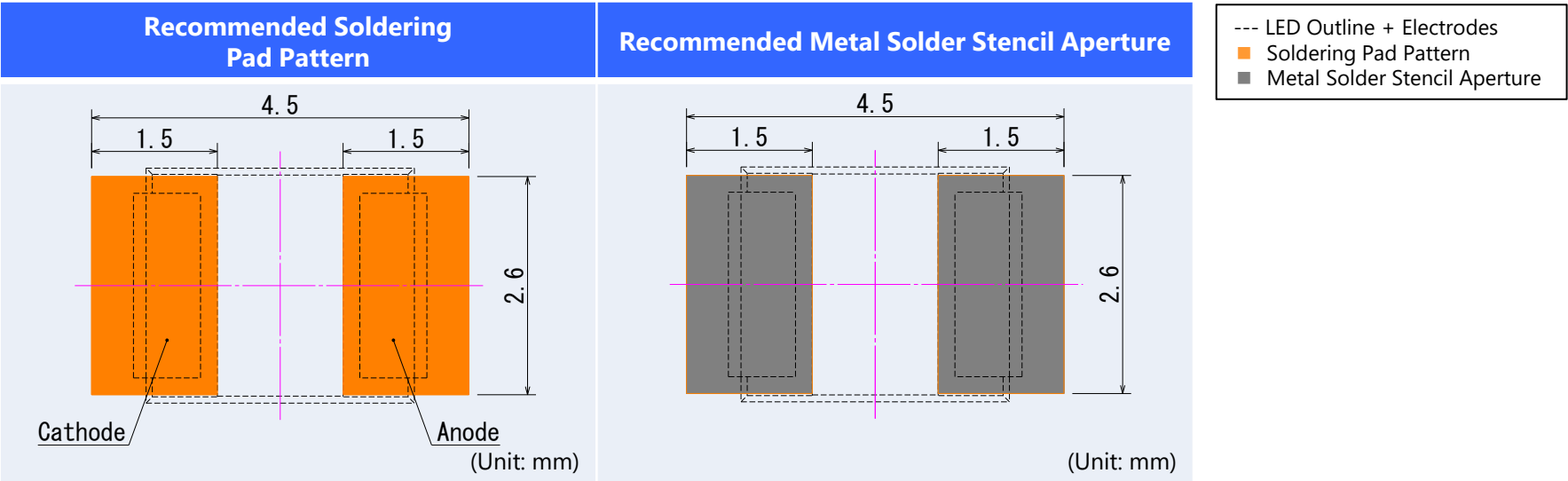

Table 4. Recommended Solder/Metal Solder Stencil Conditions

Item	Recommended Conditions
Metal Solder Stencil (Thickness)	100μm
Solder Paste (Composition)	Sn-3.0Ag-0.5Cu

The recommended soldering pad pattern, metal solder stencil aperture, and thickness of the metal solder stencil provided in Tables 3 and 4 have been determined under Nichia’s conditions: ensure that there are no issues with the chosen assembly conditions prior to use.

This document contains tentative information, Nichia may change the contents without notice.

4. Precautions for Setting Up a Pick-and-Place Machine/Nozzle

Table 5. Cautions/Suggestions for Setting Up Equipment

Item	Recommended Conditions/Specifications	Cautions/Suggestions
Pick-and-Place Machine	Modular mounter	The recommended conditions/specifications herein have been determined using YS100 High-Speed General-Purpose Modular (manufactured by Yamaha Motor Co., Ltd.).
Pick-and-Place Nozzle	Use a nozzle that is appropriate for the dimensions of the LED.	See "4-1. Pick-and-Place Nozzle" on Page 6 for details.
Tape-and-Reel Feeder	Electrical (motorized) feeder Tape width: 8mm Feeder pitch: 4mm	See "4-2. Tape-and-Reel Feeder" on Page 7 for details.
Top Cover Tape Removal Position	Sufficiently far away from the LED pick-up position.	See "4-2. Tape-and-Reel Feeder" on Page 7 for details.
Nozzle Height for Pick-up Operations	The contact surface of the nozzle head for pick operations should be adjusted to the height of the edge of the embossed carrier tape pocket.	See "4-3. Recommended Nozzle Height for Pick-up Operations" on Page 8 for details
Nozzle Height for Placement Operations (i.e. Placement Depth)	0.2mm for placement depth	See "4-4. Recommended Nozzle Height for Placement Operations (Placement Depth)" on Page 8 for details.
Imaging-based Automatic Inspection	Using the electrode as a reference is recommended to locate the center of the LED.	See "4-5. Imaging-based Automatic Inspection" on Page 9 for details.

This document contains tentative information, Nichia may change the contents without notice.

4-1. Pick-and-Place Nozzle

1. Use a nozzle that is appropriate for the LED (i.e. the nozzle dimensions are appropriate for the dimensions of the recommended pick-up position for the LED).
Do not use a nozzle that is smaller than the emitting area of the LED (i.e. $\phi 2.4$ mm); otherwise, it may damage the emitting surface causing the LED not to illuminate.

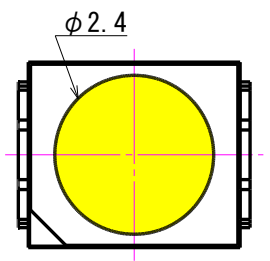

Figure 2. Emitting Area of the LED

2. Figure 3 shows an example of a recommended nozzle tip. Figure 4 shows correct/incorrect examples for shapes of the nozzle and LED pick-up positions for reference purposes.

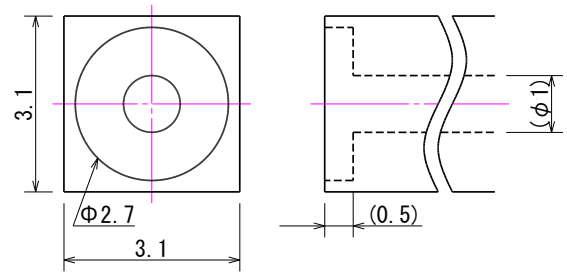

Figure 3. Example of a Recommended Nozzle Tip

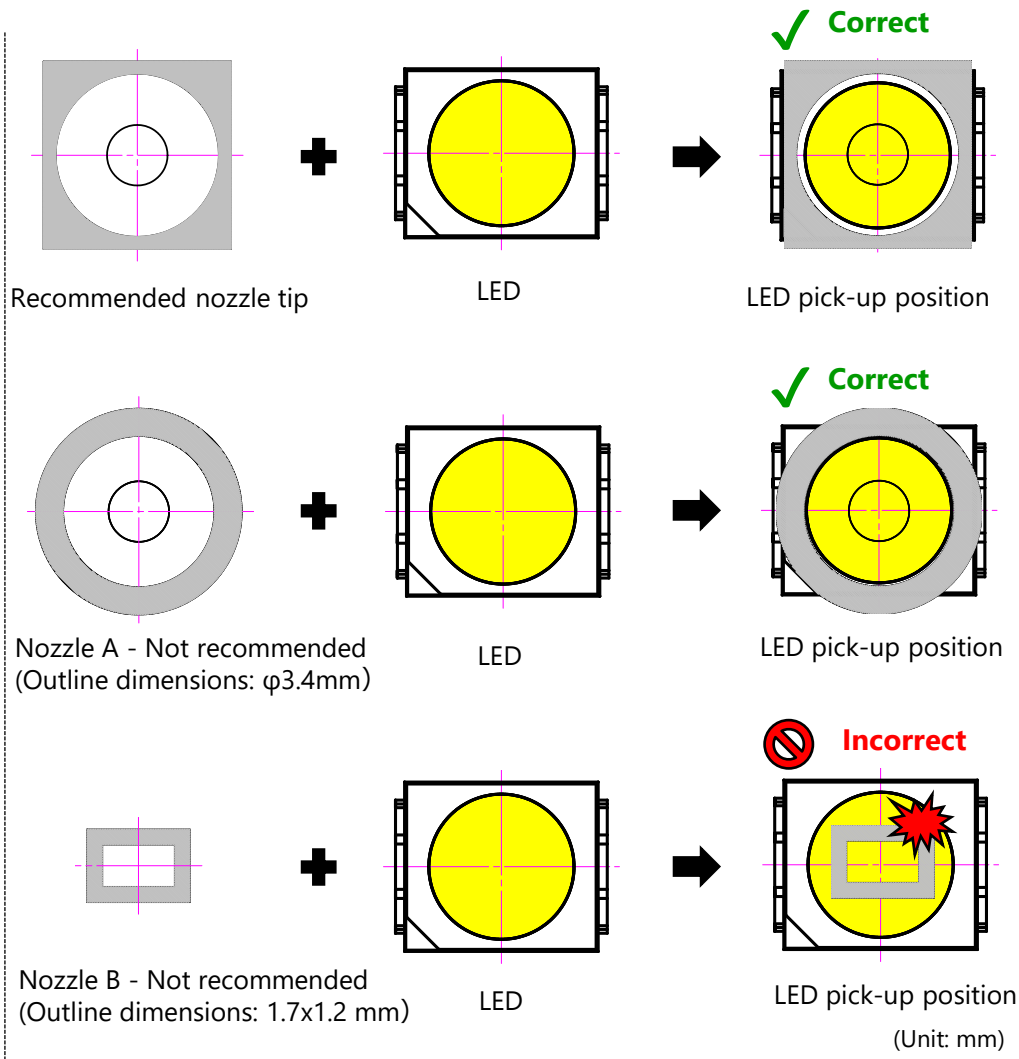
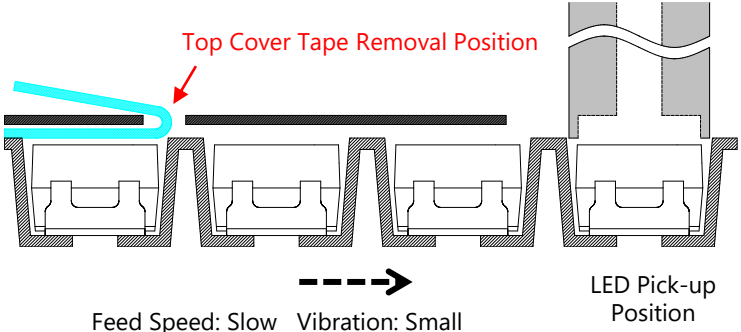

Figure 4. Correct/Incorrect Examples for Shapes of the Nozzle and LED Pick-up Positions

This document contains tentative information, Nichia may change the contents without notice.

4-2. Tape-and-Reel Feeder

• It is **recommended** to remove the top cover tape at a point sufficiently far away from the LED pick-up position.



• It is **not recommended** to remove the top cover tape immediately before LED pick-up.

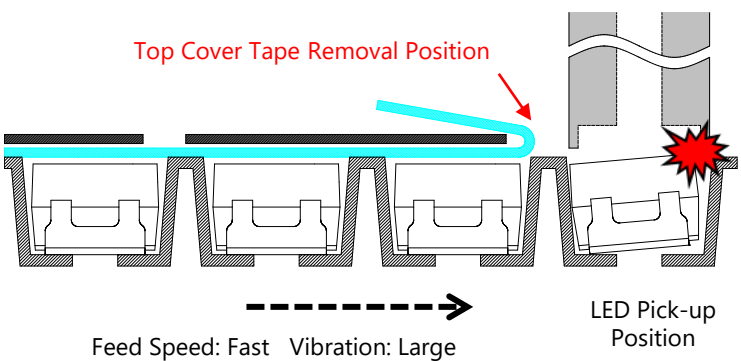

1. For the tape-and-reel feeder, the tape width is set to 8mm and the feeder pitch is set to 4mm.
2. Use a tape-and-reel feeder that ensures it does not create excessive vibrations causing assembly issues (e.g. an electrical [motorized] feeder).
 - When the tape feeder feed rate is fast, the LEDs in the embossed carrier tape pockets may not be in the correct position when picked by the nozzle; it may be improved by reducing the tape feeder feed rate.
3. It is recommended to remove the top cover tape at a point sufficiently far away from the LED pick-up position.

• If the top cover tape is removed right next to where the nozzle picks up the LEDs, regardless of whether the LEDs have been baked or not, it may cause the LED to be picked up incorrectly; it is recommended to remove the top cover tape further from where the nozzle picks up the LEDs.

Figure 5. Examples of Recommended/Not Recommended Top Cover Tape Removal Positions

4-3. Recommended Nozzle Height for Pick-up Operations

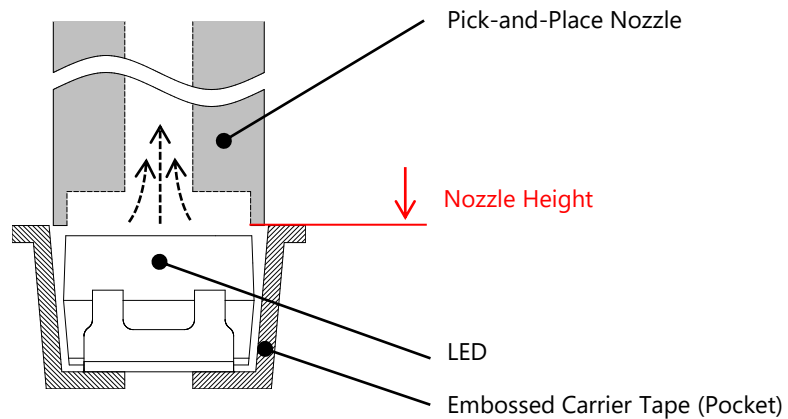

Figure 6. Recommended Nozzle Height for Pick-up Operations

4-4. Recommended Nozzle Height for Placement Operations (Placement Depth)

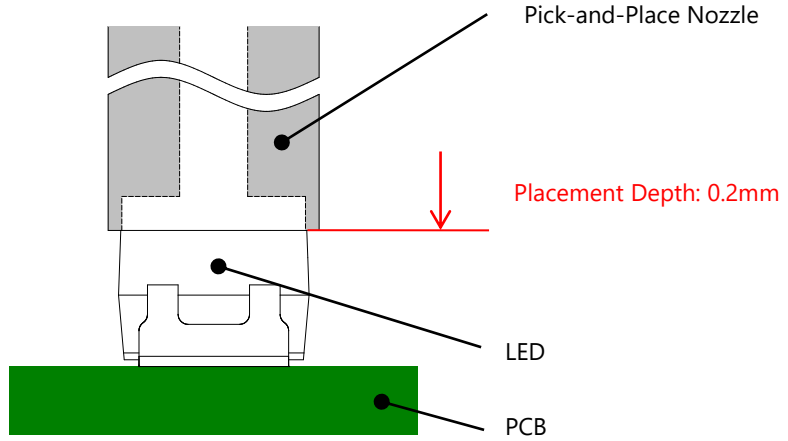

Figure 7. Recommended Nozzle Height for Placement Operations (Placement Depth)

1. The nozzle should go down only to the height of the edge of the embossed carrier tape pocket.
If it is necessary to insert the nozzle into the pocket due to the shape and/or the size of the nozzle tip, it may go down onto the LED in the tape pocket until the tip touches the LED.
2. The recommended nozzle height for pick-up operations has been determined by Nichia under the verification conditions and may not function as expected with some other pick-and-place machines. If the pick-up operations are unstable even with using the recommended nozzle height, adjust the nozzle height appropriate for the pick-and-place machine being used.
 - If the pick point of the nozzle is too high,
 - it may cause insufficient suction power leading to picking errors (e.g. the nozzle's failure to pick/lift the LED into the air, incorrect picking causing the LED to tilt when in the air).
 - If the pick point of the nozzle is too low,
 - it may cause issues (e.g. causing the embossed carrier tape to shake, causing the tape pocket to deform) leading to picking failure.

1. The nozzle should further press the LED 0.2mm onto the PCB from the height where the LED first touches solder paste.
 - If the release point of the nozzle is too high,
 - it may cause placement issues (e.g. the LED to stick to the nozzle after placement, the LED to be mounted in an incorrect place/rotated position, the LED to become soldered to the PCB in a tilted position, etc.).
 - If the release point of the nozzle is too low,
 - excessive forces may be applied to the LED during placement and it may cause the LED to become damaged.

This document contains tentative information, Nichia may change the contents without notice.

4-5. Imaging-based Automatic Inspection

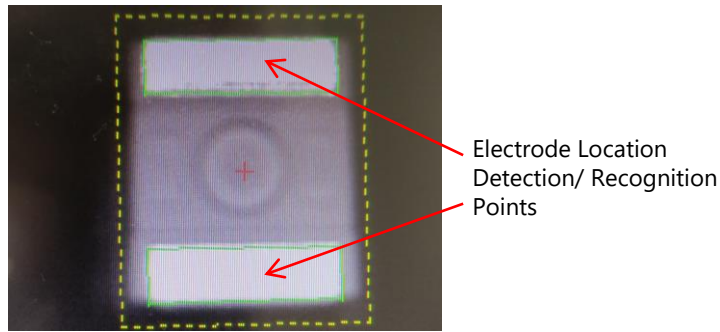

Figure 8. Recommended Reference Points to Detect, Recognize, or Locate the Electrodes

1. Nichia recommends using the electrodes as a reference to locate the center of the LED.
2. If the imaging device has trouble detecting/recognizing the electrodes, adjust the settings (i.e. the brightness of the light, etc.) of the pick-and-place machine.

5. Precautions When Reflow Soldering

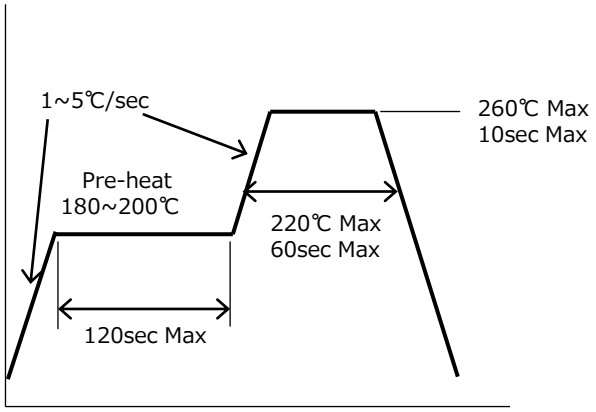

Figure 9. Recommended Reflow Soldering Condition (Lead-free Solder)

1. Reflow soldering must not be performed more than twice.
2. Nichia recommends using the reflow soldering conditions detailed in Figure 9 to the left; use the recommended reflow conditions specified by the manufacturer of the solder paste being used if it works better for the chosen application.

Note: To ensure that these reflow conditions have no negative effect on the LEDs, perform sufficient verification prior to use.

3. When cooling the LEDs from the peak temperature a gradual cooling slope is recommended; do not cool the LEDs rapidly.
4. During reflow soldering, the heat and atmosphere in the reflow oven may cause the optical characteristics to degrade. In particular, reflow soldering performed with an air atmosphere may have a greater negative effect on the optical characteristics than if a nitrogen atmosphere is used; Nichia recommends using a nitrogen reflow atmosphere.

This document contains tentative information, Nichia may change the contents without notice.

Disclaimer

This application note is a controlled document of Nichia Corporation (Nichia) published to provide technical information/data for reference purposes only. By using this application note, the user agrees to the following:

- This application note has been prepared solely for reference on the subject matters incorporated within it and Nichia makes no guarantee that customers will see the same results for their chosen application.
- The information/data contained herein are only typical examples of performances and/or applications for the product. Nichia does not provide any guarantees or grant any license under or immunity from any intellectual property rights or other rights held by Nichia or third parties.
- Nichia makes no representation or warranty, express or implied, as to the accuracy, completeness or usefulness of any information contained herein. In addition, Nichia shall not be liable for any damages or losses arising out of exploiting, using, or downloading or otherwise this document, or any other acts associated with this document.
- The content of this application note may be changed without any prior or subsequent notice.
- Copyrights and all other rights regarding the content of this document are reserved by Nichia or the right holders who have permitted Nichia to use the content. Without prior written consent of Nichia, republication, reproduction, and/or redistribution of the content of this document in any form or by any means, whether in whole or in part, including modifications or derivative works hereof, is strictly prohibited.

NICHIA CORPORATION 491 Oka, Kaminaka-Cho, Anan-Shi,
TOKUSHIMA 774-8601, JAPAN
<http://www.nichia.co.jp> Phone: +81-884-22-2311 Fax: +81-884-21-0148

This document contains tentative information, Nichia may change the contents without notice.